

COBOT HC20DTP

Human-Collaborative Robot 6 integrated Sensors



The Cobot HC20DTP is the largest robot of the HC product family, with a remarkable payload of 20 kg, an enormous max. reach of 1,900 mm and outstanding repeatability. This makes the robot an ideal choice for fenceless palletizing tasks, such as in end-of-line packaging applications. However, applications in harsh environments, e.g. machine tool loading, are also possible without any problems thanks to its resistant surface coating and IP67 protection class against coolants and dust. The food-grade grease also opens up further applications in the food and pharmaceutical industries. Thanks to the integrated torque sensors in each joint, the robot can be used in human-robot collaboration without any protection fence. A connection flange common in the cobot world and configuration wizard software simplify the connection of grippers.

The HC robot series from Yaskawa was developed for easy entry into robotic automation. In addition to the simple programming philosophy with hand guidance/operator buttons on the robot's wrist, online tutorials and application builders on the web make it easier to take the first steps in robot automation. The convenient tablet-based Smart Pendant guides you intuitively through the individual steps – from programming to safety configuration, simple menus provide the perfect overview of your application. Simply set up the cobot, after connecting the robot and all components, you're ready to start programming the task. Many compatible accessories – supplied either by Yaskawa or ecosystem partners – make it easy to set up robot installations for many applications.

KEY BENEFITS

Easy-to-use

- Simple programming with Smart Pendant incl. Smart Frame and hand guiding
- Complex programming with Teach Pendant
- Pendants with standard 3-position enabling switch
- Wizard programming for applications and accessories
- Ecosystem of Plug & Play partner products
- ISO flange for easy connection of accessories
- Yaskawa simulation software MotoSim EG VRC

Smart safety

- PL d Cat. 3 certification with 25 safety-related hardware and software functions
- High-resolution torque sensors in each joint
- Easy configuration of the safety unit, such as definition of ranges, plains and precise envelopes for manipulator and gripper
- Two retract movements: Retract & Clamp Release function
- Pushback function for pushing the robot away during operation

Industrial design for hybrid operation

- High payload and reach
- IP67 protection class with high-quality seals
- Food grade grease
- Robust aluminium cast in lightweight design
- Powerful Yaskawa 200 V servo drives
- Internal media routing
- Automatic calibration
- Fast axis speeds
- Industrial control options YRC1000 and YRC1000micro

Controlled by
YRC1000

Controlled by
**YRC1000
micro**

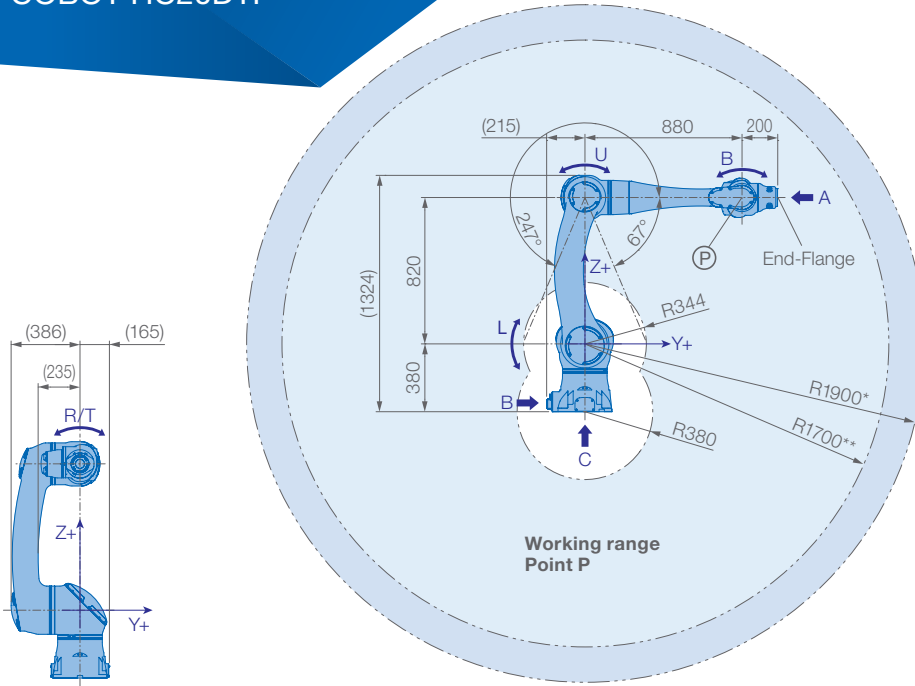

* Absolute reach: S/L-Axis center of rotation to R/T-Axis center of rotation
 ** Effective reach: S/L-Axis center of rotation to Point P

View A

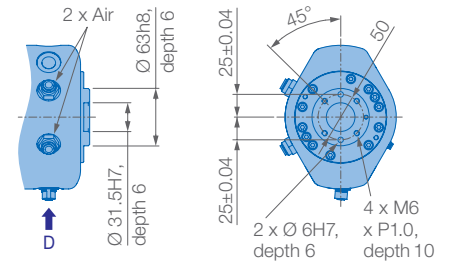

View B

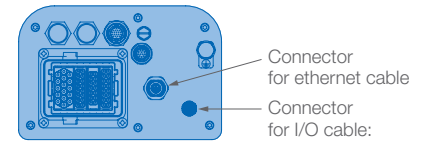

View C

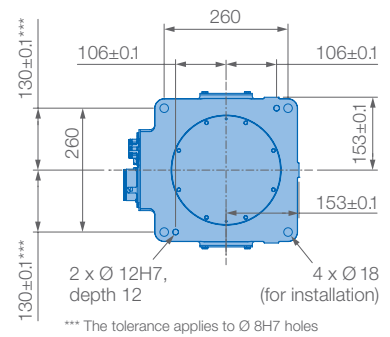

Mounting options: Floor, ceiling, wall, tilt*
 IP Protection: IP67

* S Axis motion limits – see table left side

View D

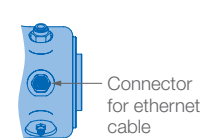

View E

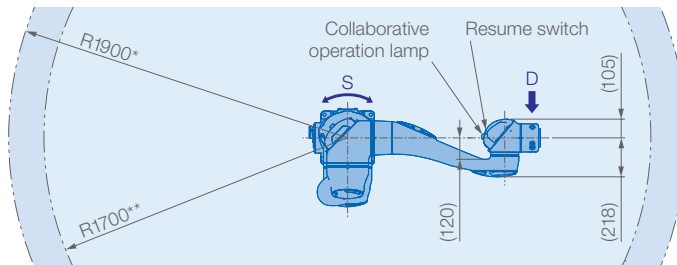
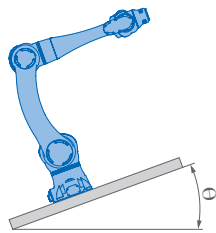
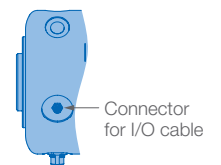

Allowable wrist load

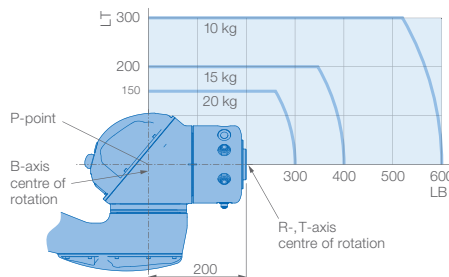

Robot installation angle θ [deg.]	S-axis operating range [deg.]
$0 \leq \theta \leq 30$	± 210 max. (no limit)
$30 < \theta \leq 35$	± 60 max.
$35 < \theta \leq 45$	± 45 max.
$45 < \theta$	± 30 max.

Specifications HC20DTP					
Axes	Maximum motion range [°]	Maximum speed [°/s]	Allowable moment [Nm]	Allowable moment of inertia [kg · m ²]	Controlled axes
S	± 210	80	–	–	6
L	± 180	80	–	–	Max. payload [kg]
U	+247/–67	120	–	–	Repeatability [mm]
R	± 210	130	58.8	4.0	Max. working range R [mm]
B	± 180	180	58.8	4.0	Temperature [°C]
T	± 210	180	29.4	2.0	Humidity [%]
					Weight [kg]
					Power supply, average [kVA]

* Absolute reach: S/L-Axis center of rotation to R/T-Axis center of rotation ** Effective reach: S/L-Axis center of rotation to Point P

Yaskawa Europe GmbH

Robotics Division
 Yaskawastraße 1
 85391 Allershausen
 Germany

Tel. +49 (0) 8166 90-0
 robotics@yaskawa.eu
 www.yaskawa.eu

YR-1-06VXCP20-B00
 B-11-2023, A-No. 220876