

YASKAWA AC Drive-V1000 Option DeviceNet Installation Manual

Type: SI-N3/V

To properly use the product, read this manual thoroughly and retain for easy reference, inspection, and maintenance. Ensure the end user receives this manual.

V1000オプションユニット DeviceNet通信 取扱説明書

形式 SI-N3/V

製品を安全にお使いいただくために、本書を必ずお読みください。
また、本書をお手元に保管していただくとともに、最終的に本製品をご使用になるユーザー様のお手元に確実に届けられるよう、お取り計らい願います。

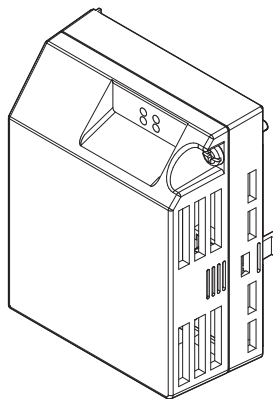

Copyright © 2007 YASKAWA ELECTRIC CORPORATION

All rights reserved. No part of this publication may be reproduced, stored in a retrieval system, or transmitted, in any form or by any means, mechanical, electronic, photocopying, recording, or otherwise, without the prior written permission of Yaskawa. No patent liability is assumed with respect to the use of the information contained herein. Moreover, because Yaskawa is constantly striving to improve its high-quality products, the information contained in this manual is subject to change without notice. Every precaution has been taken in the preparation of this manual. Yaskawa assumes no responsibility for errors or omissions. Neither is any liability assumed for damages resulting from the use of the information contained in this publication.

Table of Contents

1	PREFACE AND SAFETY	4
2	OVERVIEW	9
3	RECEIVING	11
4	DEVICENET OPTION COMPONENTS	12
5	INSTALLATION PROCEDURE	17
6	DEVICENET OPTION DRIVE PARAMETERS	26
7	TROUBLESHOOTING	30
8	CONFIGURING DEVICENET MESSAGING	34
9	EUROPEAN STANDARDS	38
10	SPECIFICATIONS	40

1 Preface and Safety

Yaskawa manufactures products used as components in a wide variety of industrial systems and equipment. The selection and application of Yaskawa products remain the responsibility of the equipment manufacturer or end user. Yaskawa accepts no responsibility for the way its products are incorporated into the final system design. Under no circumstances should any Yaskawa product be incorporated into any product or design as the exclusive or sole safety control. Without exception, all controls should be designed to detect faults dynamically and fail safely under all circumstances. All systems or equipment designed to incorporate a product manufactured by Yaskawa must be supplied to the end user with appropriate warnings and instructions as to the safe use and operation of that part. Any warnings provided by Yaskawa must be promptly provided to the end user. Yaskawa offers an express warranty only as to the quality of its products in conforming to standards and specifications published in the Yaskawa manual. **NO OTHER WARRANTY, EXPRESS OR IMPLIED, IS OFFERED.** Yaskawa assumes no liability for any personal injury, property damage, losses, or claims arising from misapplication of its products.

◆ Applicable Documentation

The following manuals are available for the DeviceNet Option:

Option Unit

	YASKAWA AC Drive -V1000 Option SI-N3/V DeviceNet Installation Manual Manual No: TOEP C730600 28 (This book)	Read this manual first. The installation manual is packaged with the option and contains a basic overview of wiring, settings, functions, and fault diagnoses.
	YASKAWA AC Drive -V1000 Option SI-N3/V DeviceNet Technical Manual Manual No: SIEP C730600 28	The technical manual contains detailed information and command registers. To obtain the technical manual access these sites: U.S.: http://www.yaskawa.com Europe: http://www.yaskawa.eu.com Japan: http://www.e-mechatronics.com Other areas: contact a Yaskawa representative.

Yaskawa Drive

	YASKAWA AC Drive-V1000 Quick Start Guide	To obtain instruction manuals for Yaskawa products access these sites: U.S.: http://www.yaskawa.com Europe: http://www.yaskawa.eu.com Japan: http://www.e-mechatronics.com Other areas: contact a Yaskawa representative.
	YASKAWA AC Drive-V1000 Technical Manual	For questions, contact the local Yaskawa sales office or the nearest Yaskawa representative.

◆ Terms

Note:	Indicates a supplement or precaution that does not cause drive damage.
Drive:	YASKAWA AC Drive -V1000 Series
DeviceNet SI-N3/V Option:	YASKAWA AC Drive -V1000 Option DeviceNet
≥ 1011:	Indicates a drive feature or function that is only available in drive software version 1011 or later.

1 Preface and Safety

◆ Registered Trademarks

- DeviceNet is a trademark of the ODVA.
- All trademarks are the property of their respective owners.

◆ Supplemental Safety Information

Read and understand this manual before installing, operating, or servicing this option unit. The option unit must be installed according to this manual and local codes.

The following conventions are used to indicate safety messages in this manual. Failure to heed these messages could result in serious or possibly even fatal injury or damage to the products or to related equipment and systems.

DANGER

Indicates a hazardous situation, which, if not avoided, will result in death or serious injury.

WARNING

Indicates a hazardous situation, which, if not avoided, could result in death or serious injury.

CAUTION

Indicates a hazardous situation, which, if not avoided, could result in minor or moderate injury.

NOTICE

Indicates an equipment damage message.

■ General Safety

General Precautions

- The diagrams in this section may include option units and drives without covers or safety shields to illustrate details. Be sure to reinstall covers or shields before operating any devices. The option board should be used according to the instructions described in this manual.
- Any illustrations, photographs, or examples used in this manual are provided as examples only and may not apply to all products to which this manual is applicable.
- The products and specifications described in this manual or the content and presentation of the manual may be changed without notice to improve the product and/or the manual.
- When ordering a new copy of the manual due to damage or loss, contact your Yaskawa representative or the nearest Yaskawa sales office and provide the manual number shown on the front cover.

DANGER

Heed the safety messages in this manual.

Failure to comply will result in death or serious injury.

The operating company is responsible for any injuries or equipment damage resulting from failure to heed the warnings in this manual.

NOTICE

Do not modify the drive or option circuitry.

Failure to comply could result in damage to the drive or option and will void warranty. Yaskawa is not responsible for any modification of the product made by the user. This product must not be modified.

Do not expose the drive or option to halogen group disinfectants.

Failure to comply may cause damage to the electrical components in the drive or option unit.

Do not pack the drive in wooden materials that have been fumigated or sterilized.

Do not sterilize the entire package after the product is packed.

■ Option Unit Warning Labels

Warning information is displayed on the option unit as shown in the figure below. Follow all warnings and safety instructions when using the product.

When using the drive in an area that may require displaying warning information in Japanese or Chinese, a warning label is provided with the DeviceNet Option. This label can be placed over the English and French warnings on the front of the DeviceNet Option.

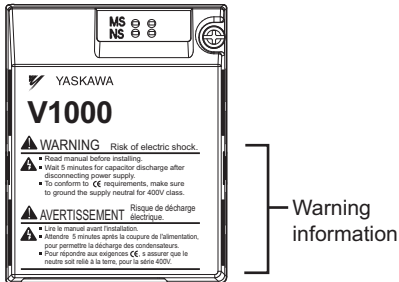

■ Warning Contents

WARNING Risk of electric shock.

- Read manual before installing.
- Wait 5 minutes for capacitor discharge after disconnecting power supply.
- To conform to **CE** requirements, make sure to ground the supply neutral for 400V class.

AVERTISSEMENT Risque de décharge électrique.

- Lire le manuel avant l'installation.
- Attendre 5 minutes après la coupure de l'alimentation, pour permettre la décharge des condensateurs.
- Pour répondre aux exigences **CE**, s'assurer que le neutre soit relié à la terre, pour la série 400V.

2 Overview

The DeviceNet option provides a communications connection between the drive and an ODVA DeviceNet network. The SI-N3/V DeviceNet Option connects the drive to a DeviceNet network and facilitates the exchange of data.

This manual explains the handling, installation and specifications of this product.

DeviceNet is a communications link to connect industrial devices (such as limit switches, photoelectric switches, valve manifolds, motor starters, smart motor controllers, operator interfaces, and variable frequency drives) as well as control devices (such as programmable controllers and computers) to a network. DeviceNet is a simple, networking solution that reduces the cost and time to wire and install factory automation devices, while providing interchangeability of "like" components from multiple vendors.

DeviceNet is an open device network standard.

By installing the DeviceNet Option to a drive, it is possible to do the following from a DeviceNet master device:

- Operate the drive
- Monitor the operation status of the drive
- Change parameter settings.



Figure 1 DeviceNet Approved

2 Overview

◆ Compatible Products

The DeviceNet Option can be used with the products in *Table 1*.

Table 1 Compatible Products

Model(s)	Software Version <I>
CIMR-V□□A□□□□AA□	≥ 1011
CIMR-V□□A□□□□BA□	≥ 1011
CIMR-V□□A□□□□FA□	≥ 1011

<I> See “PRG” on the drive nameplate for the software version number.

Note: For Yaskawa customers in the North or South America region:
If your product is not listed in *Table 1*, refer to the web page below to confirm this manual is correct for your product. The web page provides a list of option manuals by product, and a direct link to download a PDF.

Scan QR code



Or refer to: <http://www.yaskawa.com/optionlookup>

3 Receiving

Please perform the following tasks after receiving the DeviceNet Option:

- Inspect the DeviceNet Option for damage.
If the DeviceNet Option appears damaged upon receipt, contact the shipper immediately.
- Verify receipt of the correct model by checking the information on the nameplate (see Figure 1).
- If you have received the wrong model or the DeviceNet Option does not function properly, contact your supplier.

◆ Contents and Packaging

Table 2 Contents of Package

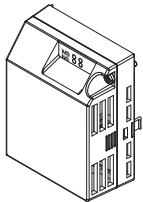
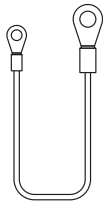
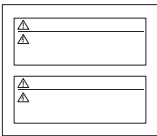
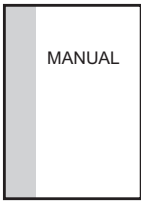
Description:	Option Unit	Ground Cables	Warning Labels	Installation Manual
-				
Quantity:	1	4	1	1

◆ Tool Requirements

A Phillips screwdriver (M3, M3.5 to M6 $\langle \rightarrow \rangle$ metric or (#1, #2 $\langle \rightarrow \rangle$ U.S. standard size) is required to install the DeviceNet Option.

$\langle \rightarrow \rangle$ Screw sizes vary by drive model. Select the appropriate screwdriver.

Note: Tools required to prepare DeviceNet cables for wiring are not listed in this manual.

4 DeviceNet Option Components

◆ DeviceNet Option

DeviceNet Option with cover attached

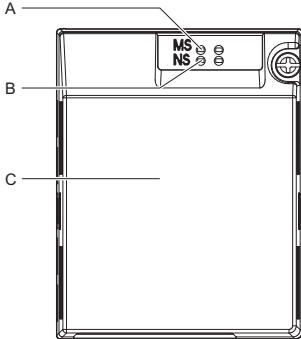

DeviceNet Option with cover removed

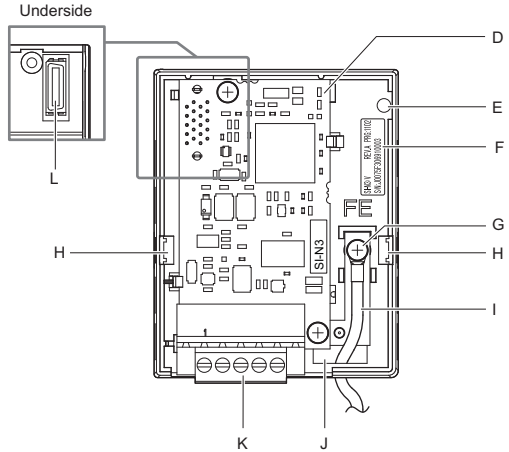

A – LED (MS) <1>

B – LED (NS) <1>

C – Option cover

D – DeviceNet PCB

E – Attachment screw hole for option cover

F – Nameplate

G – Function Earth cable connection (FE)

H – Mounting tabs

I – Ground cable <2>

J – Pass-through hole for cable

K – Terminals

L – Option connector

<1> Refer to *DeviceNet Option LED Display* on page 14 for details on the LEDs.

<2> Ground cables are packaged loose inside the DeviceNet Option shipping package and must be connected during installation.

Figure 2 Option Unit

◆ Dimensions

The installed DeviceNet Option adds 27 mm (1.06 in.) to the total depth of the drive.

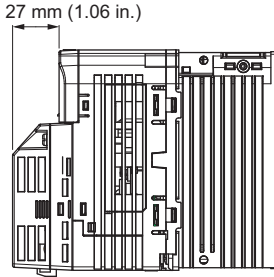

Figure 3 Dimensions

◆ Terminal

The communication connector is a pluggable terminal block. This pluggable terminal block is the connection point of the DeviceNet network communication cable to the Option.

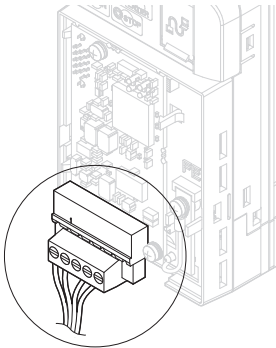
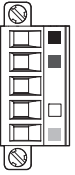

Figure 4 Pluggable terminal block

4 DeviceNet Option Components

Table 3 Communication terminal block

SI-N3/V Connector	Pin	Color	Signal	Description
	1	Black	V-	Network common
	2	Blue	CAN_L	CAN data Low
	3	–	Shield	Cable shield
	4	White	CAN_H	CAN data High
	5	Red	V+	Communications DC+24V

◆ DeviceNet Option LED Display

The DeviceNet Option has two bi-color, red/green LEDs, one for Module Status (MS) and one for Network Status (NS).

The operational states of the DeviceNet Option LEDs after the DeviceNet power-up diagnostic LED sequence is completed are described in [Table 5](#). Wait at least 2 seconds for the power-up diagnostic process to complete before verifying the states of the LEDs.

Table 4 DeviceNet Operation LED States

Name	Indication		Operating Status	Remarks
	Color	Status		
MS	–	OFF	Power supply OFF	Power is not being supplied to the drive.
	Green	ON	SI-N3/V Option operating	The SI-N3/V Option is operating normally.
	Green	Flashing	SI-N3/V Option initializing	There is an incorrect baud rate setting or there is a MAC ID.
	Red	ON	Fatal error occurred	A fatal (irrecoverable) error occurred in the SI-N3/V Option.
	Red	Flashing	Non-fatal error occurred	A non-fatal (recoverable) error occurred.
	Green/ Red	Flashing	Device self-test	Device in self-test mode.

4 DeviceNet Option Components

Name	Indication		Operating Status	Remarks
	Color	Status		
NS	–	OFF	Offline or Power supply OFF	–
	Green	ON	Online communications established	Device is on-line and has connections in the established state.
	Green	Flashing	Online communications not established	Device is on-line but has no connections in the established state. Dup Mac-ID test has been passed, is on-line but has no open connections to other nodes.
	Red	ON	Communications error	An error occurred that disables DeviceNet communications. <ul style="list-style-type: none"> • MAC ID duplication • Bus Off detected
	Red	Flashing	Communications time-out	A communications time-out occurred with the master.
	Green/ Red	Flashing	Communication faulted	Specific communication faulted device. <ul style="list-style-type: none"> • The device has detected a network access error and is in the communications faulted state. • The device has then received and accepted an Identify communication fault request-long protocol message.

■ Power-Up Diagnostics

An LED test is performed each time the drive is powered up. The initial boot sequence may take several seconds. After the LEDs have completed the DeviceNet diagnostic LED sequence, the DeviceNet Option is successfully initialized. The LEDs then assume operational conditions as shown in [Table 4](#).

Table 5 Power-Up Diagnostic LED Sequence

Sequence	Module Status (MS)	Network Status (NS)	Time (ms)
1	GREEN	OFF	250
2	RED	OFF	250
3	GREEN	GREEN	250
4	GREEN	RED	250
5	GREEN	OFF	-

4 DeviceNet Option Components

◆ Set the DeviceNet Option Card MAC ID

■ Parameter F6-50, MAC ID Setting

Range: 0~64

The MAC ID is set by drive parameter F6-50. A MAC ID setting in the range of 0~63 is considered a valid MAC ID. A value other than 0~63 indicates the MAC ID is settable via the network.

The DeviceNet Option SI-N3/V reads the MAC ID value from parameter F6-50 upon power-up and upon a network reset.

◆ Set the DeviceNet Option Baud Rate

The DeviceNet Option supports standard baud rates of 125 kbps, 250 kbps, and 500 kbps.

Table 6 Parameter F6-51 Baud Rate Setting

Description	Value
125 kbps	0
250 kbps	1
500 kbps	2
Programmable From Network	3
Auto Detect	4

■ Auto Baud Rate Sensing (F6-51=4)

Setting parameter F6-51=4, "Auto Detect" causes the DeviceNet Option to determine the data rate of the DeviceNet Network and configure itself appropriately.

Note: The capability described will only be valid when there is more than one node physically on the DeviceNet network segment. The drive digital operator will display "bUS" and the DeviceNet option LEDs will be (NS-OFF and MS=Solid Green) if it fails the process of determining the data rate, when in 'Auto Detect' mode.

5 Installation Procedure

◆ Section Safety

DANGER

Electrical Shock Hazard

Do not connect or disconnect wiring while the power is on.

Failure to comply will result in death or serious injury.

Disconnect all power to the drive, wait at least five minutes after all indicators are off, measure the DC bus voltage to confirm safe level, and check for unsafe voltages before servicing to prevent electric shock. The internal capacitor remains charged even after the power supply is turned off. The charge indicator LED will extinguish when the DC bus voltage is below 50 Vdc.

WARNING

Electrical Shock Hazard

Do not remove option board cover while the power is on.

Failure to comply could result in death or serious injury.

The diagrams in this section may include option units and drives without covers or safety shields to show details. Be sure to reinstall covers or shields before operating any devices. The option board should be used according to the instructions described in this manual.

Do not allow unqualified personnel to use equipment.

Failure to comply could result in death or serious injury.

Maintenance, inspection, and replacement of parts must be performed only by authorized personnel familiar with installation, adjustment, and maintenance of this product.

5 Installation Procedure

WARNING

Do not use damaged wires, place excessive stress on wiring, or damage the wire insulation.

Failure to comply could result in death or serious injury.

Fire Hazard

Tighten all terminal screws to the specified tightening torque.

Loose electrical connections could result in death or serious injury by fire due to overheating of electrical connections.

NOTICE

Damage to Equipment

Observe proper electrostatic discharge (ESD) procedures when handling the option unit, drive, and circuit boards.

Failure to comply may result in ESD damage to circuitry.

Never shut the power off while the drive is outputting voltage.

Failure to comply may cause the application to operate incorrectly or damage the drive.

Do not operate damaged equipment.

Failure to comply may cause further damage to the equipment.

Do not connect or operate any equipment with visible damage or missing parts.

Do not use unshielded cable for control wiring.

Failure to comply may cause electrical interference resulting in poor system performance.

Use shielded twisted-pair wires and ground the shield to the ground terminal of the drive.

NOTICE

Properly connect all pins and connectors.

Failure to comply may prevent proper operation and possibly damage equipment.

Check wiring to ensure that all connections are correct after installing the option unit and connecting any other devices.

Failure to comply may result in damage to the option unit.

◆ Wiring Diagram

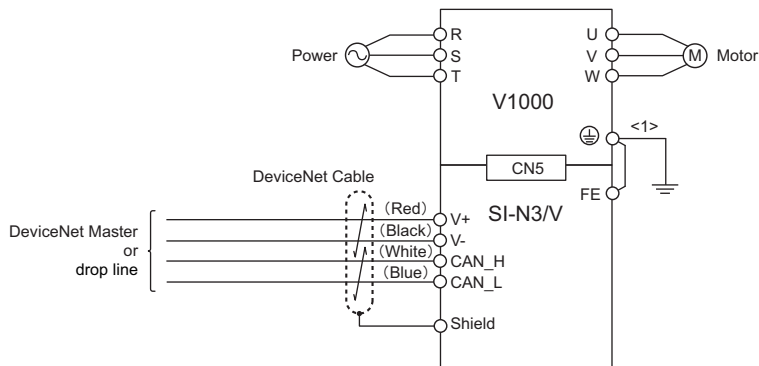

<1> The FE terminal on the DeviceNet Option is supplied with a ground cable that should be connected to the ground terminal on the drive.

Figure 5 Wiring Diagram

◆ Prior to Installing the Option Unit

Prior to installing the DeviceNet Option, wire the drive and make necessary connections to the drive terminals. Refer to the Quick Start Guide for information on wiring and connecting the drive. Verify that the drive functions normally prior to installing the Option.

5 Installation Procedure

◆ Installing the Option Unit

Remove the front cover of the drive before installing the DeviceNet Option. Follow the directions below for proper installation.

1. Switch off the power supply to the drive.

DANGER! Electrical Shock Hazard - Do not connect or disconnect wiring while the power is on. Failure to comply will result in death or serious injury. Before installing the DeviceNet Option, disconnect all power to the drive. The internal capacitor remains charged even after the power supply is turned off. The charge indicator LED will extinguish when the DC bus voltage is below 50 Vdc. To prevent electric shock, wait at least five minutes after all indicators are off and measure the DC bus voltage level to confirm safe level.

2. Remove the front cover. The original drive front cover may be discarded because it will be replaced by the DeviceNet Option cover in step 8.

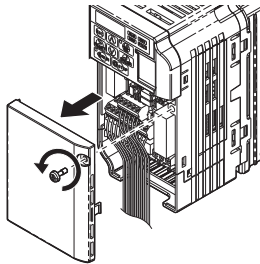

Figure 6 Remove Front Cover

3. Remove the bottom cover and connect the DeviceNet Option ground cable to the ground terminal.

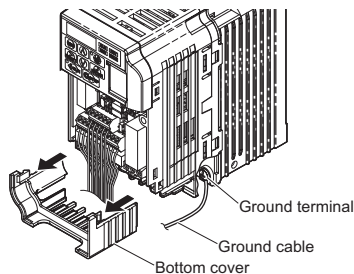
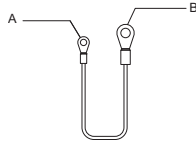

Figure 7 Connect Ground Cable

Note: The four different ground cables packaged with the DeviceNet Option connect the unit to different models. Select the proper ground cable from the DeviceNet Option kit depending on drive size.



A – Option unit connection: screw size = M3

B – Drive-side connection: screw size = M3.5 to M6

Figure 8 Ground Cable

Note: Cover removal for certain larger models with a Terminal Cover:

-Single-Phase 200 V Class: CIMR-V□BA0006 to BA0018

-Three-Phase 200 V Class: CIMR-V□2A0008 to 2A0069

-Three-Phase 400 V Class: All models

Remove the terminal cover before removing the bottom cover to install the DeviceNet Option.

Replace the terminal cover after wiring the DeviceNet Option.

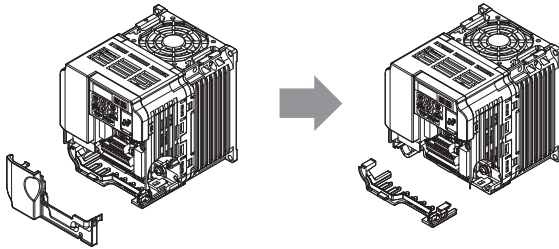

Figure 9 Models with Terminal Cover

4. Reattach the bottom cover.
5. Connect the DeviceNet Option to the drive. Properly secure the tabs on the left and right sides of the DeviceNet Option to the drive case.

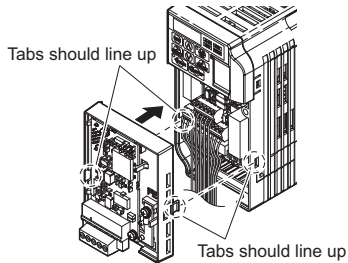

Figure 10 Attach DeviceNet Option

5 Installation Procedure

6. Connect the ground cable from the drive ground terminal to the DeviceNet Option ground. When wiring the DeviceNet Option, pass the ground cable through the inside of the drive bottom cover, then pass the ground cable into the through-hole at the front of the DeviceNet Option.

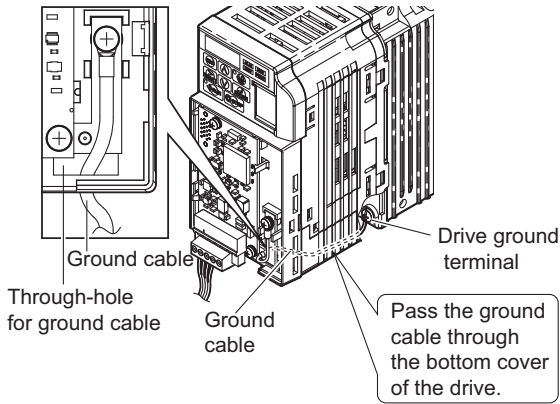

Figure 11 Ground Cable Connection

7. Connect the communications cable to the terminal block. Refer to Procedure on page 23.
8. Attach the DeviceNet Option cover to the front of the DeviceNet Option.

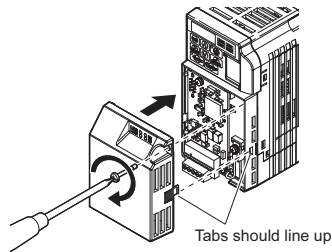

Figure 12 Attach Cover

Note: When using the drive in an area that may require displaying warning information in Japanese or Chinese, a label is provided with the DeviceNet Option. This label can be placed over the English and French warnings on the front of the DeviceNet Option.

◆ Communication Cable Wiring

■ Procedure

Follow the instructions below to connect the communications cable to the terminal block.

NOTICE: Tighten all terminal screws according to the specified tightening torque. Tightening screws too tight could damage the terminal block, and leaving screws too loose can cause a short-circuit or drive malfunction.

1. Connect the communications cable to the terminal block as shown in the diagram below.

Note: Communication lines should be separated from main circuit wiring and other electrical lines. (Tightening torque: 0.5 to 0.6 (N·m) or 4.4 to 5.3 (inch-lbs)) for Network Cable Wiring

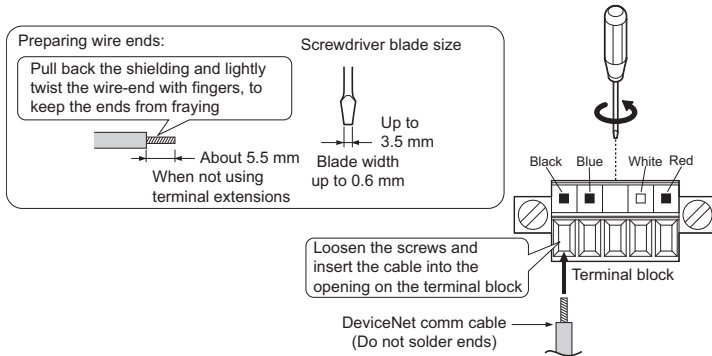

Figure 13 Network Cable Wiring

2. Ensure all wiring connections are tightened and wire insulation is not pinched in the terminal block. Remove any stray wire strands that touch other terminals.

5 Installation Procedure

3. After the terminal block is fully attached to the option unit, tighten the screws on the left and right sides of the terminal block. (Tightening torque: 0.5 to 0.6 (N·m) or 4.4 to 5.3 (inch-lbs))

Note: Be sure to put the option cover back on after all wiring is completed.

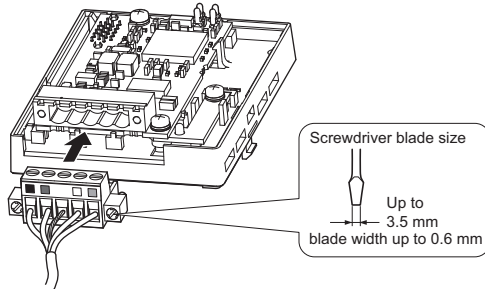

Figure 14 Terminal Board Installation

◆ Termination Resistor Connection

A network termination resistor ($121\ \Omega$, $\pm 1\%$, $1/4\ \text{W}$) must be connected only to nodes of the two ends of trunkline. Refer to ODVA specification for more details on DeviceNet termination.

◆ Communication Cable Specifications

Refer to the ODVA website for more information on network cabling.
(<http://www.odva.org/>)

◆ Cable Length

■ Trunk Line

The maximum allowed trunk line length depends on the type of cable used and the network baud rate. The total cable length includes the length of the trunk and the sum of all the drop lines.

Table 7 Trunk Line Cable Length

Baud Rate (kbps)	Thick Cable (m)	Thin Cable (m)
125	500	100
250	250	100
500	100	100

For trunk lines of mixed thick and thin cables calculate the total length at the various baud rates.

- 125 kbps: $L_{\text{thick}} + (5 \times L_{\text{thin}}) \leq 500 \text{ m}$
- 250 kbps: $L_{\text{thick}} + (2.5 \times L_{\text{thin}}) \leq 250 \text{ m}$
- 500 kbps: $L_{\text{thick}} + L_{\text{thin}} \leq 100 \text{ m}$

■ Drop Line

The drop line is measured from the tap on the trunk line to the transceiver of the DeviceNet node. Note that the total cable length includes the length of the trunk and the sum of all the drop lines.

Table 8 Drop Line Cable Length

Baud Rate (kbps)	Maximum at Each Drop (m)	Maximum Total (m)
125	6	156
250		78
500		39

◆ EDS Files

For easy network implementation of drives equipped with a SI-S3/V, an EDS file can be obtained from:

U.S.: <http://www.yaskawa.com>

Other areas: contact a Yaskawa representative

6 DeviceNet Option Drive Parameters

Confirm proper setting of the all parameters in *Table 9* before starting network communications.

Table 9 Parameter Settings

No.	Name	Description	Values
b1-01 </>	Frequency Reference Selection	Selects the frequency reference input source 0: Operator - Digital preset speed d1-01 to d1-17 1: Terminals - Analog input terminal A1 or A2 2: MEMOBUS/Modbus communications 3: Option PCB 4: Pulse Input (Terminal RP)	Default: 1 Range: 0 to 4
b1-02 </>	Run Command Selection	Selects the run command input source 0: Digital Operator - RUN and STOP keys 1: Digital input terminals S□ 2: MEMOBUS/Modbus communications 3: Option PCB	Default: 1 Range: 0 to 3
F6-01	Operation Selection after Communications Error	Determines drive response when a BUS error is detected during communications with the DeviceNet Option 0: Ramp to Stop 1: Coast to Stop 2: Fast-Stop 3: Alarm Only </>	Default: 1 Range: 0 to 3
F6-02	External Fault Detection Conditions (EF0)	Sets the condition for external fault detection (EF0) 0: Always detected 1: Detected only during operation	Default: 0 Range: 0, 1
F6-03	Stopping Method for External Fault from Communication Option	Determines drive response for external fault input (EF0) detection during DeviceNet communication 0: Ramp to Stop 1: Coast to Stop 2: Fast-Stop 3: Alarm Only </>	Default: 1 Range: 0 to 3
F6-07 <>	NetRef/ComRef Selection Function	0: Multi-step speed reference disabled (F7 mode) 1: Multi-step speed reference allowed (V7 mode)	Default: 1 Range: 0, 1
F6-08 <>	Reset Communication Related Parameters	Determines which F6-□□ and F7-□□ parameters are reset to default values when the drive is initialized using A1-03. 0: Do not reset parameters 1: Reset parameters	Default: 0 Range: 0, 1
F6-50 </>	MAC ID	Selects the drive MAC address Note: Used in the DeviceNet Object	Default: 0 </> Min: 0 </> Max: 64 </>

6 DeviceNet Option Drive Parameters

No.	Name	Description	Values
F6-51	Baud Rate	DeviceNet communication speed 0: 125 k bit/s 1: 250 k bit/s 2: 500 k bit/s 3: Programmable from Network <6> 4: Detect automatically <6> Note: Used in the DeviceNet Object	Default: 0 Range: 0 to 4 <6>
F6-52 <7>	PCA setting	I/O Polled Consuming Assembly data instance Note: Used in the Connection Object	Default: 21 Min: 0 Max: 255
F6-53 <7>	PPA setting	I/O Polled Producing Assembly data instance Note: Used in the Connection Object	Default: 71 Min: 0 Max: 255
F6-54	Idle Mode Fault Detection Selection	When detection is enabled and idle messages are detected, the option will set Run and Frequency to 0. 0: Detection enabled 1: No detection	Default: 0 Range: 0, 1
F6-55 <8>	Baud rate from Network	(Read only) DeviceNet actual communication speed 0: 125 k bit/s 1: 250 k bit/s 2: 500 k bit/s Note: Used in the DeviceNet Object	Default: 0 Range: 0 to 2
F6-56	Speed Scaling	Sets the scaling factor for the Speed Monitor in the DeviceNet Object Class 2A hex Note: Used in the AC/DC Drive Object	Default: 0 Min: -15 Max: 15
F6-57	Current Scaling	Sets the scaling factor for the Output Current Monitor in the DeviceNet Object Class 2A hex Note: Used in the AC/DC Drive Object	Default: 0 Min: -15 Max: 15
F6-58	Torque Scaling	Sets the scaling factor for the Torque Monitor in the DeviceNet Object Class 2A hex Note: Used in the AC/DC Drive Object	Default: 0 Min: -15 Max: 15
F6-59	Power Scaling	Sets the scaling factor for the Power Monitor in the DeviceNet Object Class 2A hex Note: Used in the AC/DC Drive Object	Default: 0 Min: -15 Max: 15
F6-60	Voltage Scaling	Sets the scaling factor for the Voltage Monitor in the DeviceNet Object Class 2A Note: Used in the AC/DC Drive Object	Default: 0 Min: -15 Max: 15
F6-61	Time Scaling	Sets the scaling factor for the Time Monitor in the DeviceNet Object Class 2A hex Note: Used in the AC/DC Drive Object	Default: 0 Min: -15 Max: 15
F6-62	Heart Beat	Sets the heartbeat interval Note: Used in the Identity Object	Default: 0 Min: 0 Max: 10

6 DeviceNet Option Drive Parameters

No.	Name	Description	Values
F6-63 <9>	MAC ID from Network	(Read only) Actual MAC address Note: Used in the DeviceNet Object	Default: 0 Min: 0 Max: 63
F6-64 <9>	Dynamic Output Assembly 109 Programmable Output 1 (DOA109 1)	The data in configurable output 1 is written to the MEMOBUS/Modbus address defined by this parameter.	Default: 0x0000 Min: 0x0000 Max: 0xFFFF
F6-65 <9>	Dynamic Output Assembly 109 Programmable Output 2 (DOA109 2)	The data in configurable output 2 is written to the MEMOBUS/Modbus address defined by this parameter.	Default: 0x0000 Min: 0x0000 Max: 0xFFFF
F6-66 <9>	Dynamic Output Assembly 109 Programmable Output 3 (DOA109 3)	The data in configurable output 3 is written to the MEMOBUS/Modbus address defined by this parameter.	Default: 0x0000 Min: 0x0000 Max: 0xFFFF
F6-67 <9>	Dynamic Output Assembly 109 Programmable Output 4 (DOA109 4)	The data in configurable output 4 is written to the MEMOBUS/Modbus address defined by this parameter.	Default: 0x0000 Min: 0x0000 Max: 0xFFFF
F6-68 <9>	Dynamic Input Assembly 159 Programmable Input 1 (DIA159 1)	The data in configurable input 1 is read from the MEMOBUS/Modbus address defined by this parameter.	Default: 0x0000 Min: 0x0000 Max: 0xFFFF
F6-69 <9>	Dynamic Input Assembly 159 Programmable Input 2 (DIA159 2)	The data in configurable input 2 is read from the MEMOBUS/Modbus address defined by this parameter.	Default: 0x0000 Min: 0x0000 Max: 0xFFFF
F6-70 <9>	Dynamic Input Assembly 159 Programmable Input 3 (DIA159 3)	The data in configurable input 3 is read from the MEMOBUS/Modbus address defined by this parameter.	Default: 0x0000 Min: 0x0000 Max: 0xFFFF
F6-71 <9>	Dynamic Input Assembly 159 Programmable Input 4 (DIA159 4)	The data in configurable input 4 is read from the MEMOBUS/Modbus address defined by this parameter.	Default: 0x0000 Min: 0x0000 Max: 0xFFFF
U6-98	Previous Option Fault	Displays previous faulted status. 0: No fault 1: Option failure 2: PLC in idle state 3: Forcefault 1000: Network power loss 1001: Connection timeout 1002: Duplicate MAC ID 1003: Bus-Off Note: Used in DeviceNet Option Faults	Range: 0~3; 1000~1003

6 DeviceNet Option Drive Parameters

No.	Name	Description	Values
U6-99	Current Option Fault	Displays the most recent fault status. 0: No fault 1: Option failure 2: PLC in idle state 3: Force fault 1000: Network power loss 1001: Connection timeout 1002: Duplicate MAC ID 1003: Bus-Off Note: Used in DeviceNet Option Faults	Range: 0~3; 1000~1003

- <1> To start and stop the drive with the DeviceNet master device using serial communications, set b1-02 to "3". To control the frequency reference of the drive via the master device, set b1-01 to "3".
- <2> If F6-01 is set to 3, then the drive will continue to operate when a Bus error or an EF0 fault is detected. Take proper safety measures, such as installing an emergency stop switch.
- <3> Software versions 1012 and later have F6-07 and F6-08 both set to 1.
- <4> All MAC addresses must be unique.
- <5> Software version 1011 has a setting range of 0 to 63 with a default value of 63.
- <6> F6-51=3 and 4 are not available in software version 1011. Default value is 3.
- <7> PCA and PPA will be initialized if unavailable values are set.
- <8> F6-55 and F6-63 are not available in software version 1011.
- <9> Available in the option software versions PRG: 1111 and later.

7 Troubleshooting

◆ Drive-Side Error Codes

Drive-side error codes appear on the drive's LED operator. Causes of the errors and corrective actions are listed in [Table 10](#).

For additional error codes that may appear on the LED operator screen, refer to the drive technical manual.

■ Faults

Both bUS (DeviceNet Option Communication Error) and EF0 (External Fault Input from the DeviceNet Option) can appear as an alarm or as a fault. When a fault occurs, the digital operator ALM LED remains. When an alarm occurs, the digital operator ALM LED flashes.

If communication stops while the drive is running, answer the following questions to help remedy the fault:

- Is the DeviceNet Option properly installed?
- Is the communication line properly connected to the DeviceNet Option? Is it loose?
- Is the controller program working? Has the controller CPU stopped?
- Did a momentary power loss interrupt communications?

Table 10 Fault Display and Possible Solutions

LED Operator Display		Fault Name
<i>bUS</i>	bUS	DeviceNet Option Communication Error.
		After establishing initial communication, the connection was lost. Only detected when the run command frequency reference is assigned to the option (b1-01=3 or b1-02=3).
Cause		Possible Solution
Master controller (PLC) has stopped communicating.		Check for faulty wiring.
Communication cable is not connected properly.		<ul style="list-style-type: none"> • Correct any wiring problems.
A data error occurred due to noise.		Check the various options available to minimize the effects of noise. <ul style="list-style-type: none"> • Take steps to counteract noise in the control circuit wiring, main circuit lines, and ground wiring. • If a magnetic contactor is identified as a source of noise, install a surge absorber to the contactor coil. • Make sure the cable used fulfills the DeviceNet requirements. Ground the shield on the controller side and on the DeviceNet Option side.
DeviceNet Option is damaged.		If there are no problems with the wiring and errors continue to occur, replace the DeviceNet Option.

7 Troubleshooting

Network power loss	The power on the DeviceNet network cable is 0. <ul style="list-style-type: none"> Verify power is available between option terminals V+ (red) and V- (black).
Connection time-out	The DeviceNet option Expected Packet Rate (EPR) timer timed out. <ul style="list-style-type: none"> Ensure that the EPR time is set properly.
Duplicate MAC ID	The DeviceNet option MAC ID and at least one other mode have the same MAC ID. <ul style="list-style-type: none"> Verify F6-50 is set properly.

LED Operator Display		Fault Name
EF0	EF0	External Fault Input from DeviceNet Option.
		The alarm function for an external device is triggered.
Cause		Corrective Action
An external fault is being sent from the programmable logic controller (PLC).		<ul style="list-style-type: none"> Remove the cause of the external fault. Reset the external fault input from the PLC.
Problem with the PLC program.		Check the program used by the PLC and make the appropriate corrections.
The PLC is in Idle mode.		<ul style="list-style-type: none"> Change the PLC back to Run mode. The DeviceNet option can be made to not declare EF0 when the PLC is in Idle mode by setting drive parameter F6-54 = 1(no detection).

LED Operator Display		Fault Name
oFA00	oFA00	DeviceNet Option Fault.
		DeviceNet Option is not properly connected.
Cause		Possible Solution
Non-compatible option connected to the drive.		Connect an option that is compatible with the drive.

LED Operator Display		Fault Name
oFA01	oFA01	DeviceNet Option Fault.
		DeviceNet Option is not properly connected.
Cause		Possible Solution
Problem with the connectors between the drive and DeviceNet Option.		Turn the power off and check the connectors between the drive and DeviceNet Option.

7 Troubleshooting

LED Operator Display		Fault Name
oFA03	oFA03	DeviceNet Option Fault.
		DeviceNet Option self-diagnostics error.
Cause		Possible Solution
DeviceNet Option hardware fault.		Replace the DeviceNet Option. Contact Yaskawa for assistance.

LED Operator Display		Fault Name
oFA04	oFA04	DeviceNet Option Fault.
		DeviceNet Option Flash write mode.
Cause		Possible Solution
DeviceNet Option hardware fault.		Replace the DeviceNet Option. Contact Yaskawa for assistance.

LED Operator Display		Fault Name
oFA30 to oFA43	oFA30 to oFA43	DeviceNet Option Fault (port A).
		Communication ID error.
Cause		Possible Solution
DeviceNet Option hardware fault.		Replace the DeviceNet Option. Contact Yaskawa for assistance.

■ Minor Faults and Alarms

LED Operator Display		Minor Fault Name	
CALL	CALL	Serial Communication Transmission Error.	
		Communication is not established.	
Cause		Possible Solution	Minor Fault (H2-□□ = 10)
Communication wiring is faulty, there is a short circuit, or something is not connected properly.		Check for wiring errors. <ul style="list-style-type: none"> • Correct the wiring. • Remove and ground shorts and reconnect loose wires. 	YES
Programming error on the master side.		Check communications at start-up and correct programming errors.	
Communication circuitry is damaged.		Perform a self-diagnostics check. <ul style="list-style-type: none"> • Replace the drive if the fault continues to occur. 	

◆ DeviceNet Option Error Codes

■ DeviceNet Option Fault Monitors U6-98 and U6-99

The DeviceNet Option SI-N3/V can declare the error/warning conditions via drive monitor parameters as shown in [Table 11](#).

Table 11 DeviceNet Option Fault Monitor Descriptions

Fault Condition	Fault Declared	Status Value (U6-99/U6-98)	Description
No Fault	n/a	0	No faults.
CPU Error	EF0	1	Option board failure.
PLC in Idle State	EF0	2	PLC is sending polled I/O with all data set to zero.
Force Fault	EF0	3	Network sent a message to force this node to the fault state.
Network Power Loss	BUS ERROR	1000	Power on DeviceNet network is off.
Connection Time-out	BUS ERROR	1001	This nodes timer (Expect Packet Rate) timed out.
Dup MAC ID	BUS ERROR	1002	This node and at least one other node have the same MAC ID. Another node sent it's MAC ID to the network first.
Bus-Off	BUS ERROR	1003	CAN transceiver senses network error.

Two drive monitor parameters, U6-99 (OPTN ACTIVE STAT) and U6-98 (OPTN LATCH STAT) assist the user in network troubleshooting.

- U6-99 displays the present DeviceNet Option SI-N3/V status.
- U6-98 displays the first declared fault since the last fault reset or power cycle.

These parameters are accessible from the DeviceNet network the or the drive digital operator. A drive fault reset or power off clears and refreshes both U6-99 and U6-98.

Note: In the event of a PLC idle state, the action taken by the DeviceNet Option SI-N3/V is dependent on the value of parameter F6-54 (Idle Mode Fault Detection).

8 Configuring DeviceNet Messaging

This section provides information on the various methods used to control the drive on DeviceNet.

◆ Drive Configuration on DeviceNet

■ Polled Configuration

The Drive DeviceNet Polled connection must be configured before receiving commands from a Master device. The two parameters that must be configured are:

- F6-52: Polled Consuming Assembly (PCA)
Note: Output assembly consumed by the drive.
- F6-53: Polled Producing Assembly (PPA)
Note: Input assembly produced by the drive.

The default connection paths for the DeviceNet Option are set for Extended Speed Control.

The PCA and PPA parameters can be accessed by two methods.

- A software configuration tool (not supplied), and Yaskawa Electronic Data Sheet (EDS)
Note: The PCA and PPA parameters can be accessed from the “DN: Polled Config” parameter group.
- A software configuration tool (not supplied), via a DeviceNet message path, such as (Extended Speed Control)
Note: Use DeviceNet Connection Object to change the PCA or PPA if required by the application (Class 5, Instance 1, Attributes 14 and 16)

One PCA and PPA assemblies from the following table must be selected to configure the drive for polled operation.

Table 12 Supported Polled Assemblies (PCA and PPA)

Assy Number (decimal)	Description	Type	Bytes	Page
20	Basic Speed Control Output - 20 (0x14)	PCA	4	37
21	Extended Speed Control Output - 21 (0x15) (Default Setting)	PCA	4	37
22	Speed and Torque Control Output - 22 (0x16)	PCA	6	–
23	Extended Speed and Torque Control Output - 23 (0x17)	PCA	6	–
70	Basic Speed Control Input - 70 (0x46)	PPA	4	37
71	Extended Speed Control Input - 71 (0x47) (Default Setting)	PPA	4	37
72	Speed and Torque Control Input - 72 (0x48)	PPA	6	–
73	Extended Speed and Torque Control Input - 73 (0x49)	PPA	6	–
100	MEMOBUS/Modbus Message Command (Vendor Specific Yaskawa Electric (YE) Assy) - 100 (0x64)	PCA	5	–
101	Standard Control (Vendor Specific Yaskawa Electric (YE) Assy) - 101 (0x65)	PCA	8	–

8 Configuring DeviceNet Messaging

Assy Number (decimal)	Description	Type	Bytes	Page
102	Accel/Decel Time (Vendor Specific Yaskawa Electric (YE) Assy) - 102 (0x66)	PCA	8	-
103 <1>	3-Wire Control (Vendor Specific Yaskawa Electric (YE) Assy) - 103 (0x67)	PCA	4	-
104 <2>	3-Wire Control Status (Vendor Specific Yaskawa Electric (YE) Assy) - 104 (0x68)	PPA	4	-
105	Enhanced Speed Control, Dynamic (Vendor Specific Yaskawa Electric (YE) Assy) - 105 (0x69)	PCA	8	-
106	Enhanced Control (Vendor Specific Yaskawa Electric (YE) Assy) - 106 (0x6A)	PCA	8	-
107	Standard DI/DO Control (Vendor Specific Yaskawa Electric (YE) Assy) - 107 (0x6B)	PCA	8	-
108	Enhanced Torque Control, Dynamic (Vendor Specific Yaskawa Electric (YE) Assy) - 108 (0x6C)	PCA	8	-
109 <2>	Dynamic Output Assembly (Vendor Specific Yaskawa Electric (YE) Assy) - 109 (0x6D)	PCA	8	-
120	Speed Command 1 (Vendor Specific Yaskawa Electric (YE) Assy) - 120 (0x78)	PCA	4	-
121	Torque Command 1 (Vendor Specific Yaskawa Electric (YE) Assy) - 121 (0x79)	PCA	4	-
122	Speed Command 2 (Vendor Specific Yaskawa Electric (YE) Assy) - 122 (0x7A)	PCA	6	-
123	Torque Command 2 (Vendor Specific Yaskawa Electric (YE) Assy) - 123 (0x7B)	PCA	6	-
124	Speed Dynamic Assy (Vendor Specific Yaskawa Electric (YE) Assy) - 124 (0x7C)	PCA	8	-
125	Torque Dynamic Assy (Vendor Specific Yaskawa Electric (YE) Assy) - 125 (0x7D)	PCA	8	-
126	Speed/Torque Assy (Vendor Specific Yaskawa Electric (YE) Assy) - 126 (0x7E)	PCA	8	-
130	Speed Status (Vendor Specific Yaskawa Electric (YE) Assy) - 130 (0x82)	PPA	4	-
131	Current Status (Vendor Specific Yaskawa Electric (YE) Assy) - 131 (0x83)	PPA	4	-
132	Current & Speed Status (Vendor Specific Yaskawa Electric (YE) Assy) - 132 (0x84)	PPA	6	-
134	Speed Status Dynamic Assy (Vendor Specific Yaskawa Electric (YE) Assy) - 134 (0x86)	PPA	8	-
135	Current Status Dynamic Assy (Vendor Specific Yaskawa Electric (YE) Assy) - 135 (0x87)	PPA	8	-
136	Torque and Speed Status (Vendor Specific Yaskawa Electric (YE) Assy) - 136 (0x88)	PPA	8	-
150	MEMOBUS/Modbus Message Reply (Vendor Specific Yaskawa Electric (YE) Assy) - 150 (0x96)	PPA	5	-
151	Standard Status 1 (Vendor Specific Yaskawa Electric (YE) Assy) - 151 (0x97)	PPA	8	-
152	Standard Status 2 (Vendor Specific Yaskawa Electric (YE) Assy) - 152 (0x98)	PPA	8	-
155	Enhanced Speed Status, Dynamic (Vendor Specific Yaskawa Electric (YE) Assy) - 155 (0x9B)	PPA	8	-

8 Configuring DeviceNet Messaging

Assy Number (decimal)	Description	Type	Bytes	Page
156	Enhanced Control Status (Vendor Specific Yaskawa Electric (YE) Assy) -156 (0x9C)	PPA	8	–
157	Standard DI/DO Status (Vendor Specific Yaskawa Electric (YE) Assy) - 157 (0x9D)	PPA	8	–
158	Enhanced Torque Status, Dynamic (Vendor Specific Yaskawa Electric (YE) Assy) - 158 (0x9E)	PPA	8	–
159 <2>	Dynamic Input Assembly (Vendor Specific Yaskawa Electric (YE) Assy) - 159 (0x9F)	PPA	8	–
199 <1>	Change of State Response (Vendor Specific Yaskawa Electric (YE) Assy) - 199 (0xC7)	PPA	8	–

<1> Available in the option software versions PRG: 1107 and later.

<2> Available in the option software versions PRG: 1111 and later.

◆ Drive Operation on DeviceNet

■ Polled Assemblies Quick Reference

Refer to the DeviceNet Option SI-N3/V Technical Manual for details on polled assemblies and other message types.

Output Assemblies/Drive Consumes

Instance	Byte	Bit 7	Bit 6	Bit 5	Bit 4	Bit 3	Bit 2	Bit 1	Bit 0
20 DeviceNet Basic Speed Control	0	-	-	-	-	-	Fault Reset	-	Run Fwd
	1	-							
	2	Speed Reference (Low Byte)							
	3	Speed Reference (High Byte)							

Instance	Byte	Bit 7	Bit 6	Bit 5	Bit 4	Bit 3	Bit 2	Bit 1	Bit 0
21 DeviceNet Extended Speed Control	0	-	Net Ref	Net Ctrl	-	-	Fault Reset	Run Rev	Run Fwd
	1	-							
	2	Speed Reference (Low Byte)							
	3	Speed Reference (High Byte)							

Input Assemblies/Drive Produces

Instance	Byte	Bit 7	Bit 6	Bit 5	Bit 4	Bit 3	Bit 2	Bit 1	Bit 0
70 DeviceNet Basic Speed Control	0	-	-	-	-	-	Running 1	-	Faulted
	1	-							
	2	Speed Actual (Low Byte)							
	3	Speed Actual (High Byte)							

Instance	Byte	Bit 7	Bit 6	Bit 5	Bit 4	Bit 3	Bit 2	Bit 1	Bit 0
71 DeviceNet Extended Speed Control	0	At Speed	Ref from Net	Ctrl from Net	Ready	Running 2 (REV)	Running 1 (FWD)	Warning	Faulted
	1	-							
	2	Speed Actual (Low Byte)							
	3	Speed Actual (High Byte)							

9 European Standards



Figure 15 CE Mark

The CE mark indicates compliance with European safety and environmental regulations. It is required for engaging in business and commerce in Europe.

European standards include the Machinery Directive for machine manufacturers, the Low Voltage Directive for electronics manufacturers, and the EMC guidelines for controlling noise.

This option displays the CE mark based on the EMC guidelines.

EMC Guidelines: 2004/108/EC

Drives used in combination with this option and devices used in combination with the drive must also be CE certified and display the CE mark. When using drives displaying the CE mark in combination with other devices, it is ultimately the responsibility of the user to ensure compliance with CE standards. After setting up the device, verify that conditions meet European standards.

◆ EMC Guidelines Compliance

This drive is tested according to European standards IEC/EN61800-3 and complies with EMC guidelines.

■ Installation Method

Verify the following installation conditions to ensure that other devices and machinery used in combination with this option also comply with EMC guidelines.

1. Use dedicated shield cable for the option and external device wiring, or run the wiring through a metal conduit.
2. Keep wiring as short as possible. Ground the shield according to [Figure 17](#).
3. Ground the largest possible surface area of the shield to the metal conduit when using dedicated shield cable.

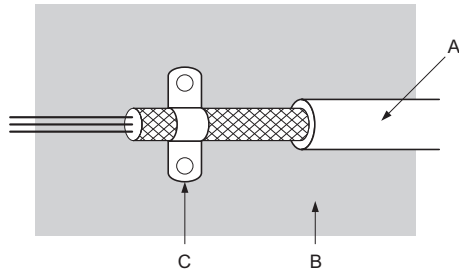

A – Braided shield cable
B – Metal panel

C – Cable clamp (conductive)

Figure 16 Ground Area

■ EMC Filter and Option Installation for CE Compliance

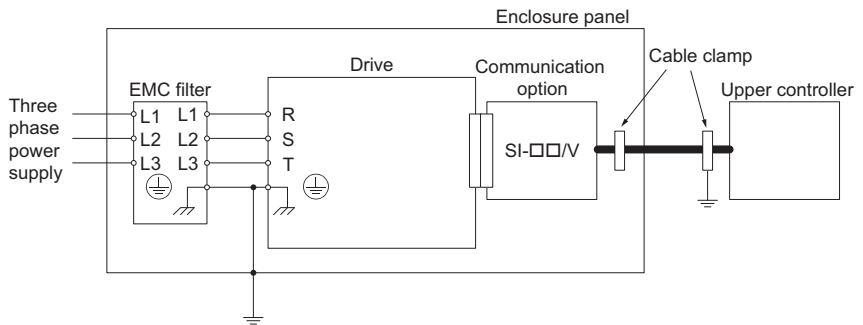

Figure 17 EMC Filter and Option Installation for CE Compliance

10 Specifications

◆ Specifications

Table 13 Option Specifications

Item	Specification
Model	SI-N3/V (PCB model: SI-N3)
SI-N3/V Supported Messages	<ul style="list-style-type: none"> • Group 2 Server (UCMM capable). • Explicit Messages: Fragmentation is supported. Up to 32 bytes can be input and output. • Polled I/O Messages: Fragmentation is not supported. Up to 8 bytes can be input and output. • Faulted Node Recovery / Offline Connection Set Messages / Automatic Device Replacement (ADR). • Change of State Message (COS). Note: COS can be used as an I/O Input Assembly.
I/O Assembly Instance	Input: 19 types (4~8 bytes) Output: 20 types (4~8 bytes)
DeviceNet Specification	Conformance Level 19: Passed
DeviceNet Profile	AC Drive
Input Power	Voltage: 11~25 Vdc Current: 40 mA
Connector Type	5-pin open-style screw connector
Physical Layer Type	Isolated Physical Layer CAN transceiver + photocoupler
MAC ID Setting	Programmable from drive keypad or network: MAC ID 0 to 63
Communications Speed/Baud Rate	Programmable from drive keypad or network: 125/250/500 kbps
Ambient Temperature	-10 °C to +50 °C (14 °F to 122 °F)
Humidity	up to 95% RH (no condensation)
Storage Temperature	-20 °C to +60 °C (-4 °F to 140 °F) allowed for short-term transport of the product
Area of Use	Indoor (free of corrosive gas, airborne particles, etc.)
Altitude	1000 m (3280 ft.) or lower

◆ Revision History

Revision dates and manual numbers appear on the bottom of the back cover.

MANUAL NO.

TOBP C730600 28B <1>

Revision number

Published in Japan June 2008

Date of publication

Date of Publication	Revision Number	Section	Revised Content
July 2017	<8>	All	Revision: Reviewed and corrected entire documentation.
		Chapter 2	Addition: Note in Table 1
		Back cover	Revision: Address
June 2016	<7>	Back cover	Revision: Address
September 2015	<6>	Front cover	Revision: Format
		Back cover	Revision: Address, format
May 2014	<5>	All	Revision: <ul style="list-style-type: none"> •Upgraded the software version to PRG: 1107 and PRG: 1111. •Reviewed and corrected entire documentation.
		Chapter 9	Addition: European standards
		Back cover	Revision: Address
October 2011	<4>	Front cover, back cover	Revision: Format
October 2010	<3>	Back cover	Revision: Address
July 2010	<2>	Back cover	Revision: Address
June 2008	<1>	All	Revision: Reviewed and corrected entire document (including table of contents).
		chapter 6	Addition: Parameter F6-07, F6-08.
		chapter 7	Deletion: DeviceNet Option Fault Monitors U6-98 and U6-99.
		chapter 8	Revision: Table 12 supported polled Assemblies (PCA and PPA).
December 2007	–	–	First edition

YASKAWA AC Drive-V1000 Option DeviceNet Installation Manual

DRIVE CENTER (INVERTER PLANT)

2-13-1, Nishimiyaichi, Yukukashi, Fukuoka, 824-8511, Japan
Phone: +81-930-25-2549 Fax: +81-930-25-3431
<http://www.yaskawa.co.jp>

YASKAWA ELECTRIC CORPORATION

New Pier Takeshiba South Tower, 1-16-1, Kaigan, Minatoku, Tokyo, 105-6891, Japan
Phone: +81-3-5402-4502 Fax: +81-3-5402-4580
<http://www.yaskawa.co.jp>

YASKAWA AMERICA, INC.

2121, Norman Drive South, Waukegan, IL 60085, U.S.A.
Phone: +1-800-YASKAWA (927-5292) or +1-847-887-7000 Fax: +1-847-887-7310
<http://www.yaskawa.com>

YASKAWA ELÉTRICO DO BRASIL LTDA.

777, Avenida Prapontinha, Dardema, São Paulo, 09950-000, Brasil
Phone: +55-11-3585-1100 Fax: +55-11-3585-1187
<http://www.yaskawa.com.br>

YASKAWA EUROPE GmbH

Hauptstraße 185, 65760 Eschborn, Germany
Phone: +49-6196-569-300 Fax: +49-6196-569-398
<http://www.yaskawa.eu.com> E-mail: info@yaskawa.eu.com

YASKAWA ELECTRIC KOREA CORPORATION

35F, Three IFC, 10 Gukjegeumjung-ro, Yeongdeungpo-gu, Seoul, 07326, Korea
Phone: +82-2-794-7844 Fax: +82-2-794-8495
<http://www.yaskawa.co.kr>

YASKAWA ELECTRIC (SINGAPORE) PTE. LTD.

151, Lorong Chuan, #04-02A, New Tech Park, 556741, Singapore
Phone: +65-6282-3003 Fax: +65-6289-3003
<http://www.yaskawa.com.sg>

YASKAWA ELECTRIC (THAILAND) CO., LTD.

59, 1st-5th Floor, Flourish Building, Soi Ratchadapisek 18, Ratchadapisek Road, Huaykwang, Bangkok, 10310, Thailand
Phone: +66-2-017-0089 Fax: +66-2-017-0799
<http://www.yaskawa.co.th>

YASKAWA ELECTRIC (CHINA) CO., LTD.

22F, One Corporate Avenue, No.222, Hulun Road, Shanghai, 200021, China
Phone: +86-21-5385-2200 Fax: +86-21-5385-3299
<http://www.yaskawa.com.cn>

YASKAWA ELECTRIC (CHINA) CO., LTD. BEIJING OFFICE

Room 1011, Tower W3 Oriental Plaza, No. 1, East Chang An Ave.,
Dong Cheng District, Beijing, 100738, China
Phone: +86-10-8518-4086 Fax: +86-10-8518-4082

YASKAWA ELECTRIC TAIWAN CORPORATION

12F, No. 207, Sec. 3, Beishin Rd., Shindian Dist., New Taipei City 23143, Taiwan
Phone: +886-2-8913-1333 Fax: +886-2-8913-1513 or +886-2-8913-1519
<http://www.yaskawa.com.tw>

YASKAWA INDIA PRIVATE LIMITED

#17/A, Electronics City, Hosur Road, Bangalore, 560 100 (Karnataka), India
Phone: +91-80-4244-1900 Fax: +91-80-4244-1901
<http://www.yaskawaindia.in>

YASKAWA

YASKAWA ELECTRIC CORPORATION

In the event that the end user of this product is to be the military and said product is to be employed in any weapons systems or the manufacture thereof, the export will fall under the relevant regulations as stipulated in the Foreign Exchange and Foreign Trade Regulations. Therefore, be sure to follow all procedures and submit all relevant documentation according to any and all rules, regulations and laws that may apply.

Specifications are subject to change without notice for ongoing product modifications and improvements.

© 2007 YASKAWA ELECTRIC CORPORATION

MANUAL NO.
TOBP C730600 28D <8>-0
Published in Japan July 2017
17-4-18